



Version
03.00

March
2006

Video Measurement System R&S®VSA

Five powerful instruments in one 19" unit

The Video Measurement System R&S®VSA provides the following functions in a minimum of space:

- ◆ Video and FFT analyzer
- ◆ Three-channel oscilloscope
- ◆ Vectorscope
- ◆ Monitor
- ◆ System controller

Further features of the R&S®VSA include:

- ◆ Four video-signal inputs with 9 MHz bandwidth
- ◆ High-contrast color LCD
- ◆ Convenient menu-driven user interface

Owing to its versatility, the R&S®VSA is suitable for a wide field of applications:

- ◆ In labs and service centers
- ◆ In automatic measuring and monitoring systems
- ◆ In production and quality assurance of video equipment



ROHDE & SCHWARZ

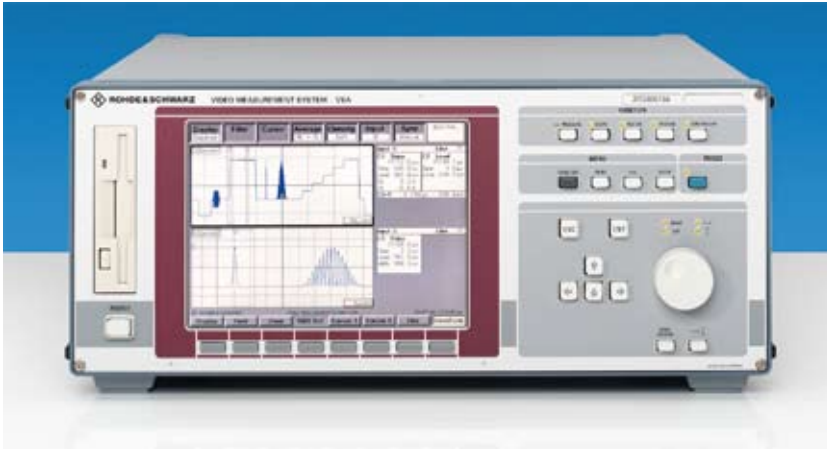

The R&S® VSA ensures fast and highly accurate analysis of all types of video signals

Versatile use

The great versatility of the Video Measurement System R&S® VSA makes it suitable for a wide range of applications.

Users in both *laboratory and service environments* will value the comprehensive measurement capabilities as well as the high operating convenience of the integrated instruments.

The integrated PC makes the R&S® VSA ideal for use as an *automatic test and monitoring system*, e.g. for TV transmitters or cable networks. No external controller is required for system control.

An integrated hard disk allows a large number of measurement results and graphics to be stored for later evaluation. This is a great advantage especially for mobile applications.

In the *production* of video equipment the R&S® VSA cannot be beaten for its high measurement speed. Results are computed virtually in realtime even if long test reports are called for, and this considerably reduces time and costs.

State-of-the-art technology

The R&S® VSA carries out the various measurement tasks with the aid of a state-of-the-art multiprocessor system that performs digital and highly accurate signal processing and controls all system interfaces.

The main features are:

- ◆ Four loop-through video-signal inputs with analog 9 MHz bandwidth
- ◆ DOS-compatible IEC/IEEE bus controller
- ◆ LCD graphics screen with 640 × 480 pixels (color TFT)
- ◆ Connectors for external keyboard and color monitor
- ◆ Two serial interfaces (RS-232-C)
- ◆ SCPI remote control via IEC/IEEE bus or serial interface
- ◆ Parallel printer interface
- ◆ Hard disk for storing results and application programs
- ◆ 3.5" floppy-disk drive (DOS format) for the transfer of measurement data or for software options

Convenient operation

Owing to the clear-cut front-panel layout and simple operation of the R&S® VSA, the user is able to safely employ the numerous functions of the measurement system without any previous knowledge of the instruments. Through the use of a high-resolution graphics display with windowing technique, pull-down menus and softkeys, the front panel is simple and logically arranged. Only a few hard keys are provided for the most important functions which can be called up directly with one keystroke.

Softkeys, cursor keys and a rotary knob are provided for the control of on-going measurements. A clear-cut menu structure makes sure that the user is not overburdened when settings are to be made.

The R&S® VSA can also be remote-controlled. In addition to the standard instrument functions, a convenient SCPI-compatible set of commands provides auxiliary functions such as reading of curves, remote polling of data stored on the hard disk or reloading and starting of automatic measurement programs. Remote control is possible simultaneously via the IEC/IEEE bus and a serial interface (in the case of remote control via modem).

Five instruments in one

Video and FFT analyzer

The R&S®VSA's analyzer function simultaneously computes a wide variety of different input signal parameters and performs automatic limit monitoring. The user can choose between four operating modes:

- ◆ Automatic overall measurement of all parameters
- ◆ Individual measurement using extended capabilities
- ◆ Test-signal and test-location display
- ◆ Standard or reference measurement separately for every parameter

In the *overall measurement mode*, all selected parameters are computed automatically and displayed in tabular form. Since the main information such as reading, limit status and test signal can be directly read from this table, the user can obtain a rapid overview of a large number of measurement parameters in this mode.

If required, the various video parameters can be examined in greater detail using the extended measurement and display capabilities of R&S®VSA in the *individual measurement mode*. Individual measurements of the frequency and group-delay spectra of (sin x)/x signals using the Fast Fourier Transform (FFT), measurements of the 2T pulse and measurements of the SC/H phase jitter and line jitter over the full field are very straightforward.

If the R&S®VSA detects out-of-tolerance conditions or other parameter errors, the *test-signal display* is a valuable tool for fast error diagnosis. The waveform of the evaluated test line is displayed with all locations used for the computation of a selected parameter. Owing to this visual check, incorrect signal insertion or missing test signals are immediately detected.

In the overall measurement mode, a wide variety of parameters can be measured and displayed in tabular form (see list under Specifications)

Parameter	Value	Unit	Status	Ref	Test Signal	Line
Diff Phase pos	0.4	deg	<input type="checkbox"/>	CCIR330	330	
Diff Phase neg	-0.2	deg	<input type="checkbox"/>	CCIR330	330	
Multiburst Flag (abs)	419.7	mV	<input type="checkbox"/>	CCIR18/6	18	
Multiburst Flag (bar)	-0.4	%/bar	<input type="checkbox"/>	CCIR18/6	18	
Multiburst 0.5MHz (%)	0.3	%/Flag	<input type="checkbox"/>	CCIR18/6	18	
Multiburst 1.0MHz (%)	0.3	%/Flag	<input type="checkbox"/>	CCIR18/6	18	
Multiburst 2.0MHz (%)	0.2	%/Flag	<input type="checkbox"/>	CCIR18/6	18	
Multiburst 4.0MHz (%)	0.7	%/Flag	<input type="checkbox"/>	CCIR18/6	18	
Multiburst 4.8MHz (%)	0.9	%/Flag	<input type="checkbox"/>	CCIR18/6	18	
Multiburst 5.8MHz (%)	1.4	%/Flag	<input type="checkbox"/>	CCIR18/6	18	
Sin x/x Amplitude pos	-0.86	dB/grat	<input type="checkbox"/>	Sin x/x	333	
Sin x/x Amplitude neg	-0.92	dB/grat	<input type="checkbox"/>	Sin x/x	333	
Sin x/x Group Delay pos	-16	ns/grat	<input type="checkbox"/>	Sin x/x	333	
Sin x/x Group Delay neg	-11	ns/grat	<input type="checkbox"/>	Sin x/x	333	
Spectrum pos	-1.74	dB/grat	<input type="checkbox"/>	CCIR17	17	
Spectrum neg	4.62	dB/grat	<input type="checkbox"/>	CCIR17	17	
Lum Noise Unw (nom)	72.2	dB/nom	<input type="checkbox"/>	Quiet	22	
Lum Noise Unw (bar)	72.2	dB/bar	<input type="checkbox"/>	Quiet	22	

Detailed analysis in the individual measurement mode

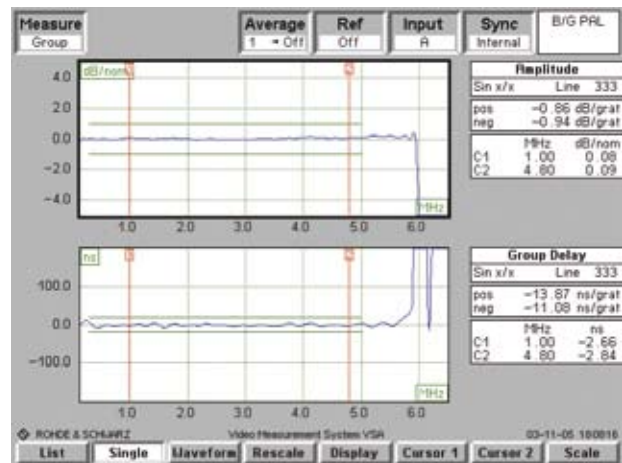

Waveform display with marked locations for visual check of evaluated test line

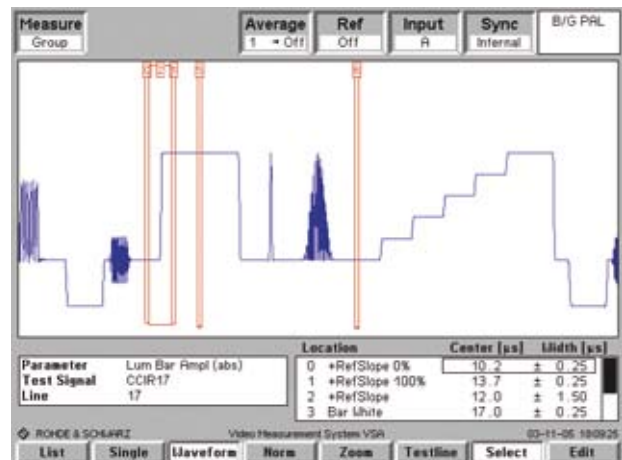

Another advantage of the analyzer function is the *reference measurement*. In this mode, the effect of the DUT on the signal can be directly displayed by simultaneously evaluating the video signal at the input and output of the DUT.

Three-channel oscilloscope

The video oscilloscope of the R&S®VSA combines a wide variety of highly practical display and measurement functions. For the display of video signals, the R&S®VSA screen may also be horizontally divided into two or three sections.

A separate input may be assigned to each section (e.g. R, G, B components) or the same signal is displayed in all three sections with different timebases. The displayed signal section may be moved continuously in the X and Y direction using the rotary knob.

For better orientation, the waveform is displayed on a dynamic measurement graticule that is automatically adapted to the displayed signal section.

A large number of digital filters, e.g. all ITU-R filters for ITS measurements, are available for simulating signal manipulations.

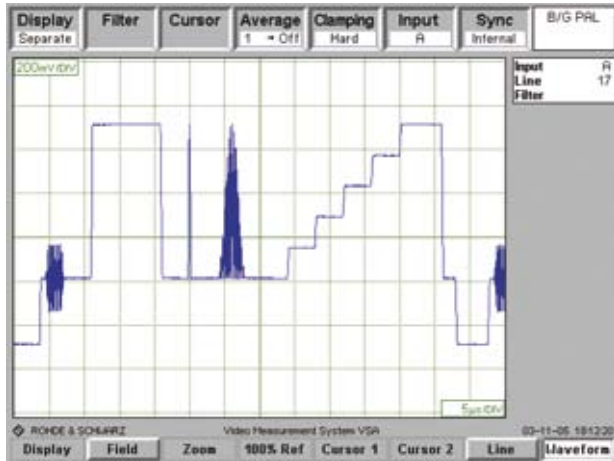

The video oscilloscope of the R&S®VSA combines a wide variety of highly practical display and measurement functions

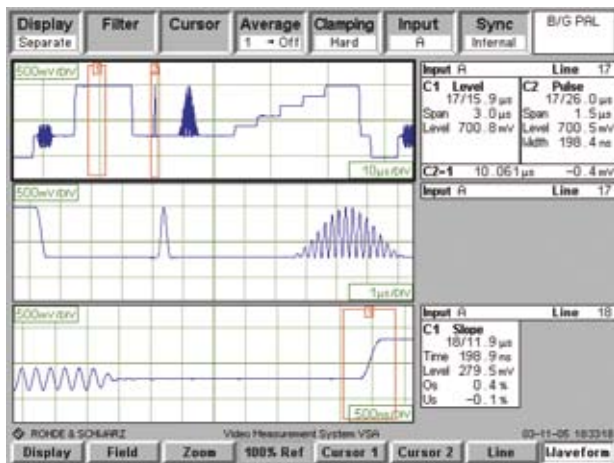

For simultaneous display of several signals, the screen may be divided into several sections

A special strength of the R&S®VSA oscilloscope is cursor measurements with two cursors being used for each partial display. With the LEVEL, PEAK, SLOPE and PULSE functions, complete signal elements can be analyzed.

Vectorscope

The vectorscope displays the magnitude and phase of the color information of a video line. For fast diagnostics the waveform of the selected line is also simultaneously displayed. The most commonly used test signal for vector analysis is the standard color bar. If this signal is available, all color-subcarrier amplitudes and phases are automatically computed and displayed. The phase difference of two color subcarriers can also be accurately measured by alternately using the color-subcarrier reference frequency of the two measured signals.

A unique feature is the measurement using a tracking cursor. A cursor line in the waveform window of the video line coincides with a marker in the vector diagram. Shifting the cursor line causes this marker to track the vector curve. This allows the color parameter for each point of the measured line to be determined.

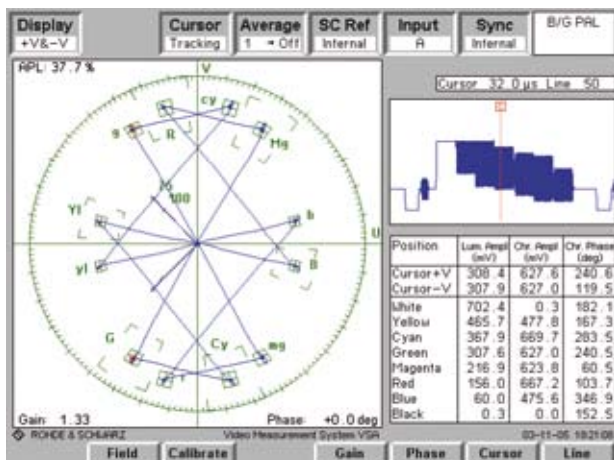

The vectorscope function displays the magnitude and phase of the color information of a video line

Monitor

At sites where several different program signals are received (e.g. in cable networks), the individual program sources have to be reliably identified.

The R&S®VSA monitor function displays a video signal as a monochrome TV picture with eight gray levels. Any video line of the TV picture selected by means of the rotary knob can be displayed simultaneously in the waveform window.

Any line of a monochrome TV picture with eight gray levels can be selected and displayed in a waveform window

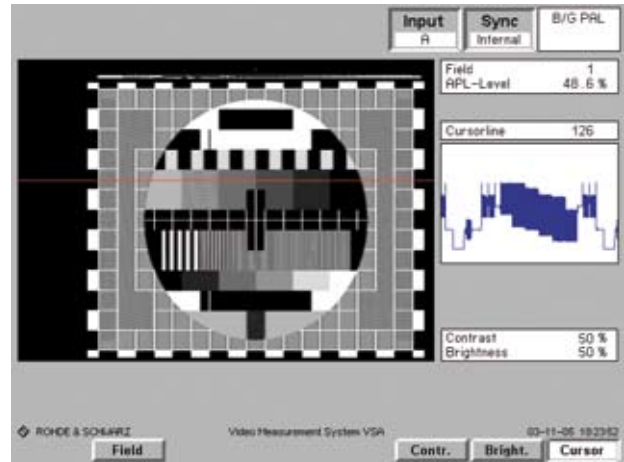

System controller

The system controller function provides the user with a complete DOS-compatible PC with integrated IEC/IEEE bus interface, printer interface and two serial interfaces. This makes the R&S®VSA a complete automatic test system capable of controlling external devices via the interfaces provided. All measurement results may be stored on the built-in hard disk or on floppies for subsequent evaluation. Individual measurement programs can be started via the pull-down menus.

R&S®VSA with external monitor and keyboard

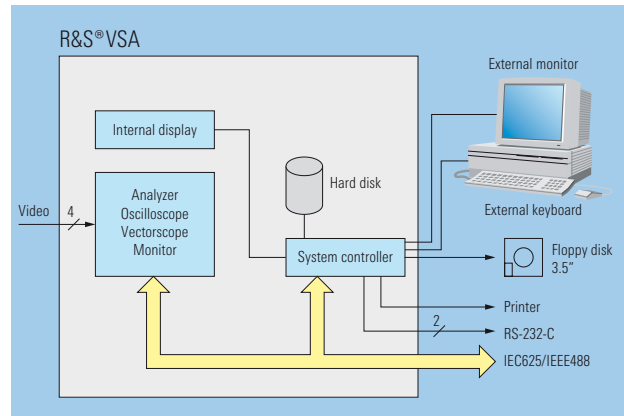

PC operation and measurement functions are independent of each other. To be able to make full use of the PC functions, interfaces are provided

for a R&S®VGA color monitor and a PC keyboard. The R&S®VSA display and the external monitor may be configured independently either for measurements or as PC display. Switchover requires just

one keystroke. The external keyboard may also be used either for PC control or for operating the measurement functions.



Rear view of the R&S®VSA

Specifications

Frequency range	0 Hz to 9 MHz
Standard	B/G, I, D/K, PAL, SECAM ¹⁾ , NTSC (option R&S®VSA-B1)
Signal inputs	
Video inputs	75 Ω loop-through filters
Level	1 V ±6 dB
Return loss up to 6 MHz	>40 dB
Return loss up to 10 MHz	>36 dB
Decoupling of inputs up to 10 MHz	>85 dB
DC input	1 MΩ
Level	±5 V
Signal outputs	
Zero-reference control pulse, 75 Ω	
Level	1.4 V
Line position and duration	adjustable
Interfaces	
Remote control	IEC 625-2/IEEE 448-2, 2 × RS-232-C (9-contact)
Printer	parallel interface (Centronics)
External monitor	640 × 480 pixels, VGA color monitor
External keyboard	PC AT keyboard
Display	640 × 480 pixels, color TFT

General data

Operating temperature range	0 °C to +50 °C
Power supply	100/230 V, -10/+15 %, 120/240 V, -15/+10 %, 47 Hz to 63 Hz, 310 VA
Mechanical stress	
Sinusoidal vibration	5 Hz to 150 Hz, max. 2 g at 55 Hz, 0.5 g from 55 Hz to 150 Hz, meets IEC 68-2-6, IEC 1010-1, MIL-T-28800 D, class 5
Random vibration	10 Hz to 300 Hz, 1.2 g rms
Shock	40 g shock spectrum in line with MIL-STD-810 C and MIL-T-28800 D, classes 3 and 5
Climatic conditions	+25 °C/+40 °C cyclic at 95 % rel. humidity, meets IEC 68-2-30
EMC	meets EMC directive of EU (89/336/EEC) and German EMC regulations
Electrical safety	meets EN 61010-1
Dimensions (W × H × D)	435 mm × 192 mm × 460 mm
Weight	17.7 kg

Measurement parameters

Measurement parameters	Unit	Range	Resolu- tion	Max. error ²⁾
Amplitude and delay				
Luminance bar amplitude (abs)	mV	0 to 1400	0.1	±2.0
Luminance bar amplitude (nom)	%	-100 to +100	0.1	±0.3
Sync amplitude (abs)	mV	60 to 600	0.1	±2.0
Sync amplitude (nom)	%	-80 to +100	0.1	±0.5
Sync amplitude (bar)	%	-50 to +50	0.1	±0.5
Burst amplitude (abs)	mV	60 to 600	0.1	±3.0
Burst amplitude (nom)	%	-80 to +100	0.1	±1.0
Burst amplitude (bar)	%	-50 to +50	0.1	±1.0
C/L gain (modulated pulse)	%/bar	-50 to +50	0.1	±1.0
C/L delay (modulated pulse)	ns	-500 to +500	1	±5
C/L gain (modulated bar)	%/bar	-50 to +50	0.1	±1.0
Average picture level (bar)	%	0 to 200	0.1	±3.0
DC level	mV	-2000 to +2000	0.1	±3.0
Residual picture carrier	%	0 to +30	0.1	±0.3
Residual picture black level	%	50 to 90	0.1	±0.3
Linear distortions				
Baseline distortion (bar)	%	-40 to +40	0.1	±0.3
2T pulse amplitude (bar)	%	-50 to +50	0.1	±0.5
2T k factor	%	0 to 10	0.1	±0.5
2T half-amplitude duration	ns	100 to 400	1.0	±3
Tilt	%	-40 to +40	0.1	±0.3
Short/field-time distortion	%	-40 to +40	0.1	±0.3
Nonlinear distortions				
C/L intermodulation (pulse)	%/bar	-50 to +50	0.1	±1.0
C/L intermodulation (bar), step 1/2/3	%	-50 to +50	0.1	±0.3
C NL gain, pos/neg	%	0 to +50/-50	0.1	±0.7
C NL gain, pp	%	0 to 100	0.1	±1.0
C NL phase, pos/neg	deg	0 to +50/-50	0.1	±0.7
C NL phase, pp	deg	0 to 100	0.1	±1.0
Luminance NL	%	0 to 50	0.1	±0.5
Luminance NL, step 1/2/3/4/5	%	50 to 100	0.1	±0.5
Differential gain, ref (bar)	%	-50 to +50	0.1	±0.3
Differential gain, pos/neg	%	0 to +50/-50	0.1	±0.3
Differential gain, pp	%	0 to 100	0.1	±0.5
Diff. gain, step 1/2/3/4/5	%	-50 to +50	0.1	±0.3
Differential phase, pos/neg	deg	0 to +50/-50	0.1	±0.3
Differential phase, pp	deg	0 to 100	0.1	±0.5
Differential phase, step 1/2/3/4/5	deg	-50 to +50	0.1	±0.3

Measurement parameters	Unit	Range	Resolution	Max. error ²⁾
Frequency response				
Multiburst flag (abs)	mV	0 to 1000	0.1	±2.0
Multiburst flag (nom)	%	-100 to +50	0.1	±0.3
Multiburst flag (bar)	%	-100 to +50	0.1	±0.3
Multib 0.5/1/2/4/4.8/5.8	%	-100 to +50	0.1	±1.0
Multib 0.5/1/2/4/4.8/5.8	dB	-40 to +6	0.01	±0.1
Multib (national) flag (abs)	mV	0 to 1000	0.1	±2.0
Multib (nat) flag (nom/bar)	%	-100 to +50	0.1	±0.3
Multib nat 0.5/1.5/3.0/4.4	%	-100 to +50	0.1	±1.0
Multib nat 0.5/1.5/3.0/4.4	dB	-40 to +6	0.01	±0.1
Sin x/x amplitude, pos/neg	dB	-100 to +100	0.01	±0.3
Sin x/x group delay, pos/neg	ns	-1000 to +1000	1.0	±20
Spectrum, pos/neg	dB	-100 to +100	0.01	±0.3
Noise measurements				
Lum noise, unw (abs)	mV	0 to 50	0.1	±1.0
Lum noise, unw (nom/bar)	dB	25 to 75	0.1	±1.0
Lum noise, lumw (abs)	mV	0 to 50	0.1	±1.0
Lum noise, lumw (nom/bar)	dB	25 to 80	0.1	±1.0
Lum noise, chrw (abs)	mV	0 to 50	0.1	±1.0
Lum noise, chrw (nom/bar)	dB	25 to 80	0.1	±1.0
Hum (abs)	mV	0 to 700	1	±5
Hum (nom/bar)	dB	0 to 55	0.1	±1.0
C/SND intermodulation (abs)	mV	0 to 50	0.1	±1.0
C/SND intermod (nom/bar)	dB	30 to 70	0.1	±1.0
SND/SND intermod (abs)	mV	0 to 50	0.1	±1.0
SND/SND intermod (nom/bar)	dB	30 to 70	0.1	±1.0
Timing measurements				
Field period, first/sec. field	ms	20 000 ±30	0.001	±0.005
Equalizing pulse duration	ms	1.35 to 3.35	0.001	±0.005
Serration pulse duration	ms	2.70 to 6.70	0.001	±0.005
Line period	ms	60 to 68	0.001	±0.005
Line blanking (nom/bar)	ms	7 to 65	0.001	±0.05
Sync duration	ms	2.7 to 6.7	0.001	±0.005
Sync slope, neg/pos	ms	70 to 1000	1	±5
Burst position	ms	4.7 to 6.0	0.001	±0.01
Burst duration	ms	1.5 to 3.0	0.001	±0.01
SC/H, line/average	deg	-90 to +90	1	±4
SC/H, pos p/neg p/pp	deg	-90 to +90	1	±4
PAL phase, line/average	deg	0 to 180	1	±4
PAL phase, pos p/neg p/pp	deg	0 to 180	1	±4
SC frequency	Hz	4433618 ±100	0.05	±1
Jitter measurements				
Field jitter, pos p/neg p/pp	ms	0 to 30	0.001	±0.005
Field jitter, std. deviation	ms	0 to 30	0.001	±0.005
Line jitter, pos p/neg p/pp	ns	0 to 4000	1	±5
Line jitter, std. deviation	ns	0 to 4000	1	±5

Measurement parameters	Unit	Range	Resolution	Max. error ²⁾
Video data measurements				
Basic amplitude (abs)	mV	0 to 1400	1	±10
Basic amplitude (nom/bar)	%	-100 to +100	0.1	±2.0
Amplitude, pp (nom/bar)	%	-100 to +100	0.1	±2.0
Amplitude, pp (basic ampl)	%	-100 to +100	0.1	±2.0
Decoding/timing margin	%	0 to 100	0.1	±2.0
Run-in bits	-	6 to 24	-	-
Data timing	ms	10 to 14	0.001	±0.01

Available functions for different signal types

	Video and FFT analyzer	3-channel oscilloscope	Vectorscope	Control monitor
CCVS	•	•	•	•
R/G/B ³⁾	• ⁴⁾	• ⁵⁾		
Y/Cb/Cr	• ⁴⁾	• ⁵⁾		• ⁶⁾
Y/U/V	• ⁴⁾	• ⁵⁾		• ⁶⁾
S-VHS ³⁾	same as CCVS (signals added) or RGB (signals separated)			

¹⁾ SECAM without color subcarrier measurements.

²⁾ Specified error limits apply to nominal parameter values with an averaging factor of ≥8.

³⁾ Described in detail in the Rohde & Schwarz Application Note 7BM29_0D/E.

⁴⁾ Only one component at a time.

⁵⁾ Requires sync pulse in the signal or via an additional sync signal.

⁶⁾ Only for Y component.

Ordering information

Designation	Type	Order No.
Video Measurement System (with color display)	R&S®VSA	2013.6057.04
Firmware Standard M, NTSC	R&S®VSA-B1	2013.9504.02
19" Adapter for Rackmounting	R&S®ZZA-94	0396.4905.00
Service manual		2013.7499.24



More information at
www.rohde-schwarz.com
(search term: VSA)



ROHDE & SCHWARZ

www.rohde-schwarz.com

Europe: +49 1805 12 4242, customersupport@rohde-schwarz.com
USA and Canada: 1-888-837-8772, customer.support@rsa.rohde-schwarz.com
Asia: +65 65130488, customersupport.asia@rohde-schwarz.com